

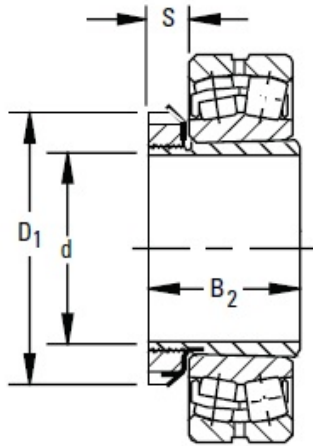

NTN-SNR BEARING RULMENTI S.R.L.



timken SNW-26 x 4 1/2 SNW/SNP-Pull-Type Sleeve, Locknut, Lockwasher/Lockplate Assemblies

Bearing No. SNW-26 x 4 1/2

Series	222K
Diameter d	4 1/2 in
Taper	1:12
SNW/SNP Assembly Weight	9.48 lb
Tolerance ¹	-0.005 in
B ₂	3.752 in
S	1.000 in
D ₁	6.755 in
Sleeve	S-26 x 4 1/2
Locknut	AN-26
Lockwasher and Lockplates	W-26

SNW-26 x 4 1/2 Bearing 2D drawings and 3D CAD models