

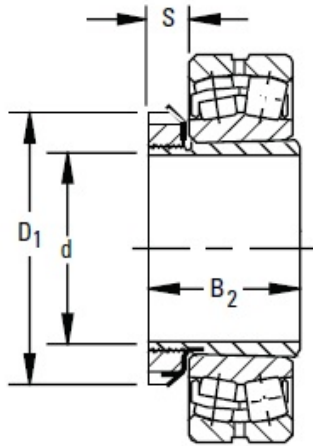

NTN-SNR BEARING RULMENTI S.R.L.



timken SNW-126 x 4 3/8 SNW/SNP-Pull-Type Sleeve, Locknut, Lockwasher/Lockplate Assemblies

Bearing No. SNW-126 x 4 3/8

Series	223K and 232K
Diameter d	4 3/8 in
Taper	1:12
SNW/SNP Assembly Weight	10.1 lb
Tolerance ¹	-0.005 in
B ₂	4.972 in
S	1.000 in
D ₁	6.755 in
Sleeve	S-126 x 4 3/8
Locknut	AN-26
Lockwasher and Lockplates	W-26

SNW-126 x 4 3/8 Bearing 2D drawings and 3D CAD models