

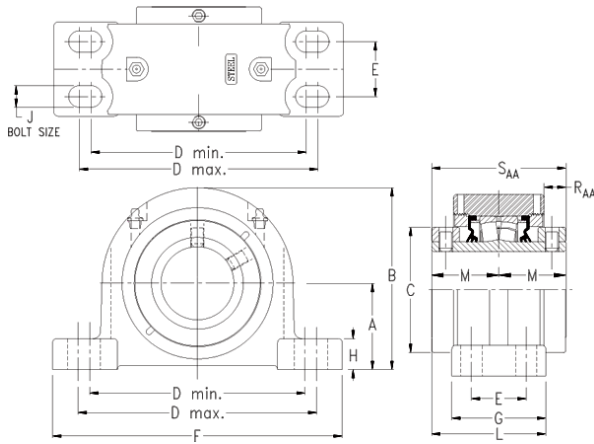

NTN-SNR BEARING RULMENTI S.R.L.



timken QAAPR15A215S Solid Block/Spherical Roller Bearing Housed Units-Double Concentric Four-Bolt Pillow Block

Bearing No. QAAPR15A215S

Engineering Group	Mounted Bearing
Shaft Size	2-15/16 in
Shaft Size Type	Imperial
Full Timken Part Number	QAAPR15A215SB
Locking Style	Double Concentric
Weight	27 lb
Housing Style	Four-Bolt Pillow Block
UPC Code	0883450030106
Dimension A	3.13 in
Dimension B	6.47 in
Dimension C	4.29 in
Dimension D Max	9.60 in
Dimension D Min	8.00 in
Dimension E	2.13 in
Dimension F	10.83 in
Dimension G	3.380 in
Dimension H	1.16 in
Dimension J (Bolt Size)	0.625 in
Dimension L	4.02 in
Dimension M	2.37 in
Dimension RAA	0.88 in
Dimension SAA	4.74 in
C0 - Static Load	54100 lb
C - Dynamic Load (Basic)	49900 lb
e - Geometry Factor	0.22

QAAPR15A215S Bearing 2D drawings and 3D CAD models



NTN-SNR BEARING RULMENTI S.R.L.

Y1 - Geometry Factor	3.14
Y2 - Geometry Factor	4.67
Oil Lubrication - M/N Seal	1600 rpm
Oil Lubrication - T Seal	2900 rpm
Oil Lubrication - B/C/O Seal	1300 rpm
Grease Lubrication - M/N Seal	1600 rpm
Grease Lubrication - T Seal	2400 rpm
Grease Lubrication - B/C/O Seal	1300 rpm
Float	0.083 in
Shaft Tolerance	0.0020 in
Eng Internal Radial Clearance - Min	0.0020
Eng Internal Radial Clearance - Max	0.0031
Pre Install Clearance Min	0.0020 in
Pre Install Clearance Max	0.0031 in