

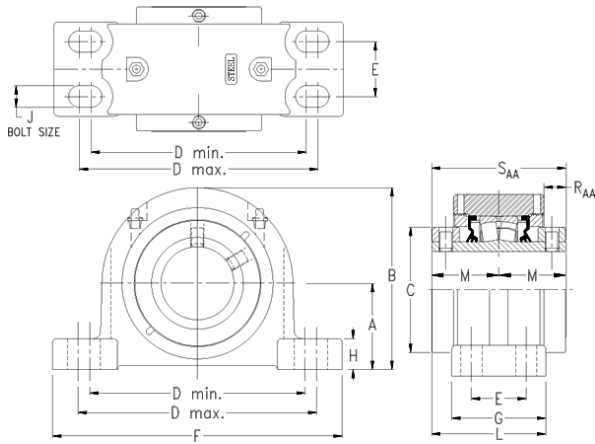

NTN-SNR BEARING RULMENTI S.R.L.



timken QAAPR18A090S Solid Block/Spherical Roller Bearing Housed Units-Double Concentric Four-Bolt Pillow Block

Bearing No. QAAPR18A090S

QAAPR18A090S Bearing 2D drawings and 3D CAD models

Engineering Group	Mounted Bearing
Shaft Size	90 mm
Shaft Size Type	Metric
Full Timken Part Number	QAAPR18A090SB
Locking Style	Double Concentric
Weight	49.0 lb
Housing Style	Four-Bolt Pillow Block
UPC Code	0883450030304
Dimension A	3.75 in
Dimension B	7.69 in
Dimension C	5.13 in
Dimension D Max	11.25 in
Dimension D Min	9.25 in
Dimension E	2.38 in
Dimension F	13.63 in
Dimension G	3.7500 in
Dimension H	1.56 in
Dimension J (Bolt Size)	0.750 in
Dimension L	4.47 in
Dimension M	2.59 in
Dimension RAA	0.84 in
Dimension SAA	5.18 in
C0 - Static Load	87200 lb
C - Dynamic Load (Basic)	79700 lb
e - Geometry Factor	0.23



NTN-SNR BEARING RULMENTI S.R.L.

Y1 - Geometry Factor	2.90
Y2 - Geometry Factor	4.31
Oil Lubrication - M/N Seal	1400 rpm
Oil Lubrication - T Seal	2400 rpm
Oil Lubrication - B/C/O Seal	1000 rpm
Grease Lubrication - M/N Seal	1400 rpm
Grease Lubrication - T Seal	2000 rpm
Grease Lubrication - B/C/O Seal	1000 rpm
Float	0.083 in
Shaft Tolerance	0.0030 in
Eng Internal Radial Clearance - Min	0.0024
Eng Internal Radial Clearance - Max	0.0039
Pre Install Clearance Min	0.0024 in
Pre Install Clearance Max	0.0039 in