

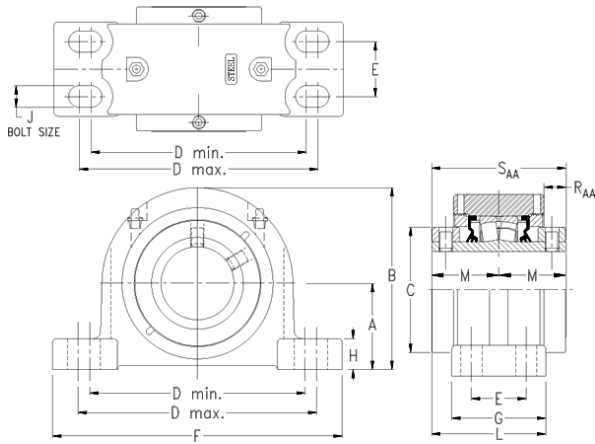

NTN-SNR BEARING RULMENTI S.R.L.



timken QAAPR18A304S Solid Block/Spherical Roller Bearing Housed Units-Double Concentric Four-Bolt Pillow Block

Bearing No. QAAPR18A304S

QAAPR18A304S Bearing 2D drawings and 3D CAD models

Engineering Group	Mounted Bearing
Shaft Size	3-1/4 in
Shaft Size Type	Imperial
Full Timken Part Number	QAAPR18A304SB
Locking Style	Double Concentric
Weight	49.0 lb
Housing Style	Four-Bolt Pillow Block
UPC Code	0883450322256
Dimension A	3.75 in
Dimension B	7.69 in
Dimension C	5.13 in
Dimension D Max	11.25 in
Dimension D Min	9.25 in
Dimension E	2.38 in
Dimension F	13.63 in
Dimension G	3.7500 in
Dimension H	1.56 in
Dimension J (Bolt Size)	0.750 in
Dimension L	4.47 in
Dimension M	2.59 in
Dimension RAA	0.84 in
Dimension SAA	5.18 in
C0 - Static Load	87200 lb
C - Dynamic Load (Basic)	79700 lb
e - Geometry Factor	0.23



NTN-SNR BEARING RULMENTI S.R.L.

Y1 - Geometry Factor	2.90
Y2 - Geometry Factor	4.31
Oil Lubrication - M/N Seal	1400 rpm
Oil Lubrication - T Seal	2400 rpm
Oil Lubrication - B/C/O Seal	1000 rpm
Grease Lubrication - M/N Seal	1400 rpm
Grease Lubrication - T Seal	2000 rpm
Grease Lubrication - B/C/O Seal	1000 rpm
Float	0.083 in
Shaft Tolerance	0.0030 in
Eng Internal Radial Clearance - Min	0.0024
Eng Internal Radial Clearance - Max	0.0039
Pre Install Clearance Min	0.0024 in
Pre Install Clearance Max	0.0039 in